

4" acrobat LED Pinhole Downlight - Warm Dimming

IC/CP Shallow New Construction Housing

Round or Square / Trimmed or Trimless

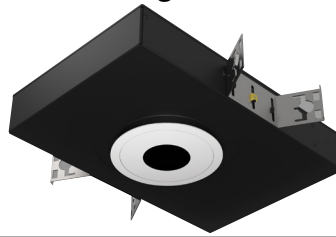

Wattage	CCT	Delivered Lumens	Efficacy
10W	1850 - 3000K	680lm	68lpw
15W	1850 - 3000K	990lm	66lpw
20W	1850 - 3000K	1280lm	64lpw

Lumens will vary depending on CCT, optic & lens option

Description

Acrobat Air Tight IC/Chicago Plenum downlight delivers over 1250lm through a 2-1/2" pinhole with four optical distributions. Delivered lumens are maintained in different ceiling thicknesses.

LED Light Engine

Warm dimming LED technology provides the natural sensation of circadian rhythm.

Field Replaceable Dimming Driver

- Power factor > 0.9, 50/60Hz
- Multiple dimming drivers available
- Complies with IEEE62.41 surge protection

Housing

18 gauge galvanized steel housing and junction box with 1/2" trade size knockouts. Includes universal butterfly brackets to accommodate C-Channel, adjustable bar hangers, and EMT. C-Channel is recommended for T-bar ceilings and must be ordered separately. Adjustable wood joist bar hangers are included. Max. ambient temperature: 104°F (40°C)

Ceiling Thickness

- Accommodates ceiling thickness from 1/2" to 1-1/4" (Extended 2" collar available, must specify)
- Delivered lumens are maintained through entire range

Trim Style

- Die-cast aluminum pinhole trim with powder coat finishes, consult factory for custom finishes
- Trimless mud plate and wood ceiling option available

Accessories

Accommodates (2) accessories, a media holder is required. Accessories are not compatible when used with lensed trim.

Emergency

Remote inverter operates for 90 minutes with remote test switch available, requires above ceiling access.

Listing/Warranty

- Patent pending
- Five (5) year limited warranty
- UL listed to US and Canadian standards for damp locations
- UL listed to US and Canadian standards for wet locations when used with lens
- Meets ASTM E283 standards
- CCEA approved - Chicago rated



Housing Order Matrix (Example: A4-SP10S-WD10-R00)

Installation Type	Wattage	Driver	LED Light Engine	Optic	Aperture	Trim Style	Rev	Extended Collar
A4-SP (IC/CP)	10 (10W)	S ¹ (ERP, Universal Dim, Triac/ELV/0-10V 10% 120-277V) LR1 (Remote Lutron Hi-lume [®] 2-Wire 1% 120V) SR1 (Remote ERP, Universal Dim, Triac/ELV/0-10V 10% 120-277V)	-WD (Warm Dim)	10 (Spot)	-R (Round) -S (Square)	(blank) (Flanged)	00	(blank) (Standard 1-1/4")
	15 (15W)			30 (Narrow Flood)		TL (Trimless)		-2 (Up to 2")
	20 (20W)			50 (Flood) 80 (Wide Flood)		WC (Wood Ceiling)		

1. Forward and reverse phase dimming at 120V only

Trim Order Matrix (Example: A4-3RWH-WH-NL-00)

Trim	Aperture	Pinhole Finish	Flange Finish	Lens Type	Rev
A4-3	R (Round)	WH (White)	(blank) (Trimless / Wood Ceiling)	-NL (No Lens - damp location)	-00
	S (Square)	BL (Black)	-WH (White)	-FR (Frosted - wet location)	
		SA (Satin Aluminum)	-BL (Black)	-MP (Solite - wet location)	
		BZ (Bronze)	-SA (Satin Aluminum)	-CL (Clear - wet location)	
			-BZ (Bronze)		

Accessories (Note: Media holder required)

A4-MHLDR (Media Holder- required)
A4-HEX (Hex Louver)
A4-FR (Frosted Lens)
A4-MP (Solite Lens)
A4-CL (Clear Lens)
A4-LS (Linear Spread Lens)

C-Channel Bar Hangers

LCB-27 (27" C-Channel)
LCB-52 (52" C-Channel)

Optics

A4-10-OPTIC (10° Spot)
A4-30-OPTIC (30° Narrow Flood)
A4-50-OPTIC (50° Flood)
A4-80-OPTIC (80° Wide Flood)

Emergency

EM-1000 (25W LED Remote Inverter)
EM-1002 (10W LED Remote Emergency Driver)
EM-1003 (35W LED Remote Inverter)
EM-1004 (50W LED Remote Inverter)

4" acrobat LED Pinhole Downlight - Warm Dimming

IC/CP Shallow New Construction Housing

Round or Square / Trimmed or Trimless

Catalog #:

Type:

Project:

Date:

Notes:

Housing Dimensions

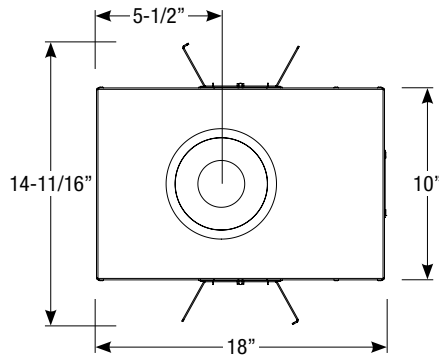
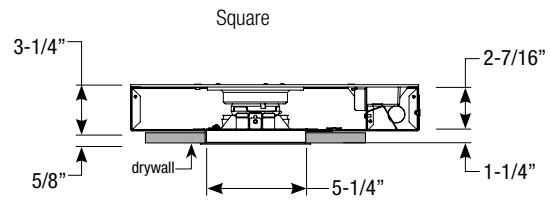
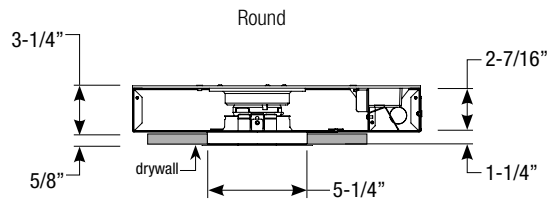

Ceiling Cut-out: 5-3/8" Ø

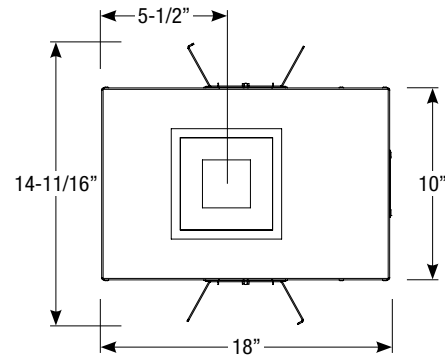

Ceiling Cut-out: 5-3/8" x 5-3/8"

Trim Dimensions

Round Trimmed

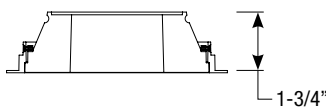

Round Trimless

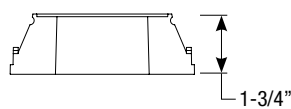

Square Trimmed

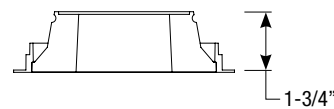

Square Trimless

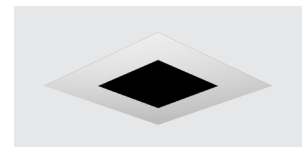
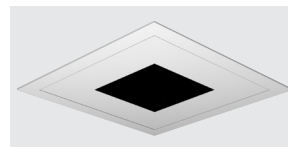
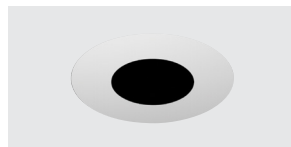
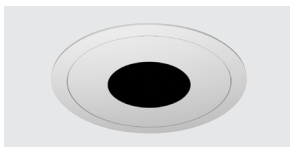
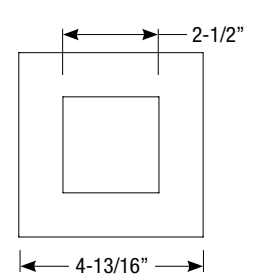
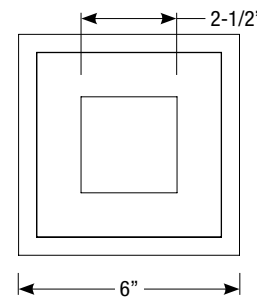
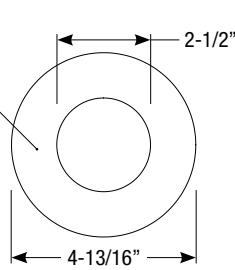
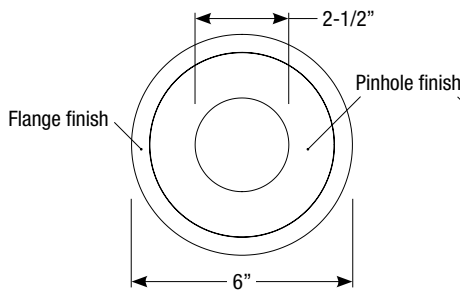
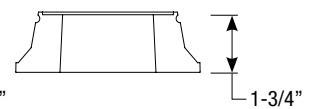

Revised 10/24/18