

# 3" acrobat LED Wall Wash- Warm Dimming Remodel Housing

Round or Square / Trimmed or Trimless

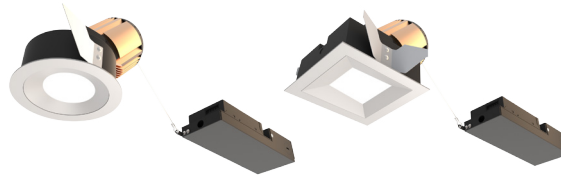

Wattage	CCT	Delivered Lumens	Efficacy
10W	1850 - 3000K	435lm	44lpw
15W	1850 - 3000K	605lm	40lpw

Lumens will vary depending on CCT, optic & lens option

### Description

- Acrobat wall wash delivers uniform vertical and horizontal wall distribution through a 3" aperture.
- Drivers are accessible from below the ceiling.

### LED Light Engine

Warm dimming LED technology provides the natural sensation of circadian rhythm.

### Field Replaceable Dimming Driver

- Power factor > 0.9, 50/60Hz
- Multiple dimming drivers available
- Complies with IEEE62.41 surge protection

### Adjustability

Locking 360° horizontal rotation. Adjust to 0° for spacing of 1.5 feet from wall and fixture opening center and 1.5 feet from fixture opening center to fixture opening center. Adjust to 5° for spacing of 2 feet from wall and fixture opening center and 2 feet from fixture opening center to fixture opening center. (Note: 2" ceiling thickness limits mechanism to 25° tilt).

### Housing

Non-IC rated housing must be kept a minimum of 3" from insulation. 18 gauge galvanized steel housing and junction box with (3) 1/2" trade size knockouts. Includes (2) steel compression clips for installation below the ceiling. Max. ambient temperature: 104°F (40°C)

### Ceiling Thickness

- Accommodates ceiling thickness from 1/2" to 2"
- Delivered lumens are maintained through entire range

### Trim Style

- Round spun aluminum cut angle trim in anodized finishes available, consult factory for custom finishes
- Square die-cast aluminum cut angle trim in powder coat finishes available, consult factory for custom finishes
- Trimless mud plate option available

### Emergency

Remote inverter operates for 90 minutes with remote test switch available, requires above ceiling access.

### Listing/Warranty

- Patent pending
- Five (5) year limited warranty
- UL listed to US and Canadian standards for damp locations



### Housing Order Matrix (Example: A3-RM10S-RWH00)

Installation Type	Wattage	Driver	Aperture	Flange Finish	Rev
<b>A3-RM</b> (Non-IC)	<b>10</b> (10W) <b>15</b> (15W)	<b>S<sup>1</sup></b> (ERP, Universal Dim, Triac/ELV/0-10V 10% 120-277V)	<b>-R</b> (Round) <b>-S</b> (Square)	<b>WH</b> (White) <b>BL</b> (Black) <b>SA</b> (Satin Aluminum) <b>BZ</b> (Bronze) <b>TL</b> (Trimless Mud Plate)	<b>00</b>
		<b>L1</b> (Lutron Hi-lume® 2-Wire 1% 120V)			
	<b>L2</b> (Lutron EcoSystem® 5% 120-277V)				
	<b>L3</b> (Lutron Hi-lume® Fade-to-Black 1% 120-277V)				
	<b>EL1</b> (eldoLED DALI 1% 120-277V)				
	<b>EL2</b> (eldoLED 0-10V 1% 120-277V)				
	<b>DMX</b> (DMX 1% 120-277V)				
	<b>LR1</b> (Remote Lutron Hi-lume® 2-Wire 1% 120V)				
	<b>SR1<sup>1</sup></b> (Remote ERP, Universal Dim, Triac/ELV/0-10V 10% 120-277V)				

1. Forward and reverse phase dimming at 120V only  
All drivers are accessible from below the ceiling.

### Trim Order Matrix (Example: A3-7RWHWD50-00)

Trim	Aperture	Reflector Finish	LED Light Engine	Optic	Rev
<b>A3-7</b>	<b>R</b> (Round) <b>S</b> (Square)	<b>WH</b> (White)	<b>WD</b> (Warm Dim)	<b>50</b> (Wall Wash)	<b>-00</b>
		<b>CA<sup>2</sup></b> (Clear Alzak)			
		<b>BL</b> (Black)			
		<b>SA</b> (Satin Aluminum)			
		<b>BZ</b> (Bronze)			

2. Available in round aperture only

### Accessories

<b>ABAT-RGNPLT-RND</b>	(Round Rough-in Plate)
<b>ABAT-RGNPLT-RND10</b>	(Round Rough-in Plate, 10pcs)
<b>ABAT-RGNPLT-RND5</b>	(Round Rough-in Plate, 5pcs)
<b>ABAT-RGNPLT-SQ</b>	(Square Rough-in Plate)
<b>ABAT-RGNPLT-SQ10</b>	(Square Rough-in Plate, 10pcs)
<b>ABAT-RGNPLT-SQ5</b>	(Square Rough-in Plate, 5pcs)

### Emergency

<b>EM-1000</b>	(25W LED Remote Inverter)
<b>EM-1002</b>	(10W LED Remote Emergency Driver)
<b>EM-1003</b>	(35W LED Remote Inverter)
<b>EM-1004</b>	(50W LED Remote Inverter)

# 3" acrobat LED Wall Wash - Warm Dimming

## Remodel Housing

Round or Square / Trimmed or Trimless

Catalog #:

Type:

Project:

Date:

Notes:

### Housing Dimensions

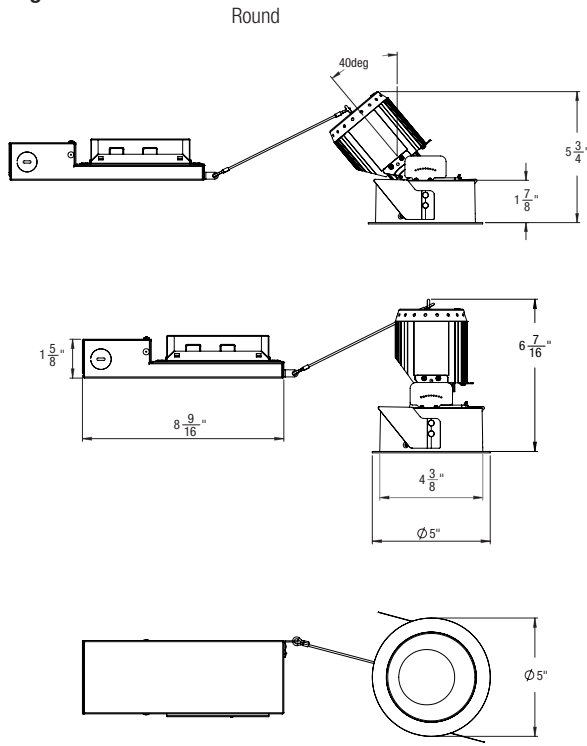

Ceiling Cut-out: 4-3/8" Ø

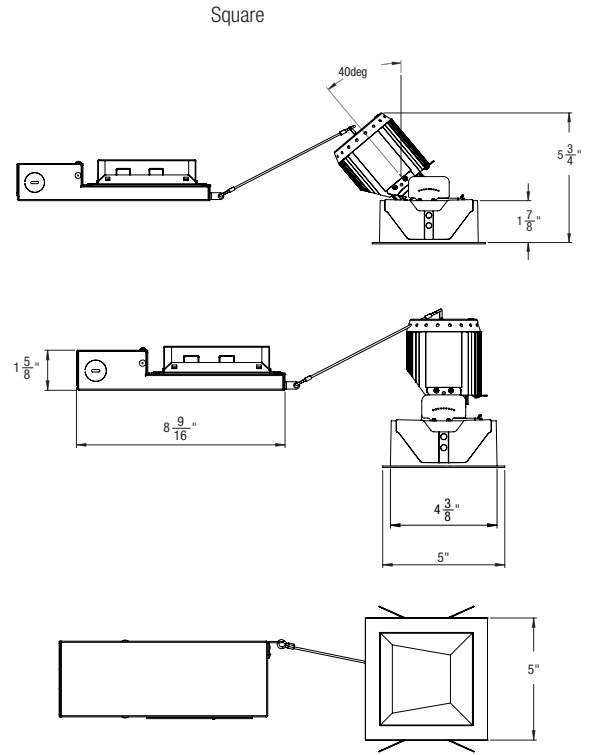

Ceiling Cut-out: 4-3/8" x 4-3/8"

### Trim Dimensions

Round Trimmed

Round Trimless

Square Trimmed

Square Trimless

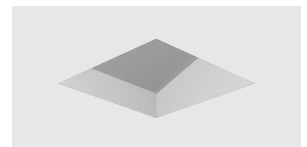
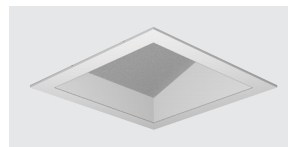
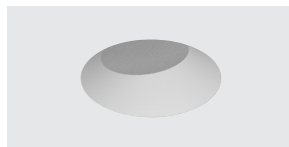
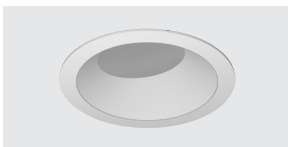
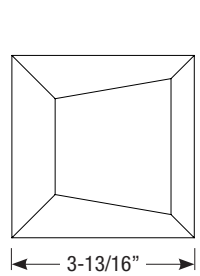
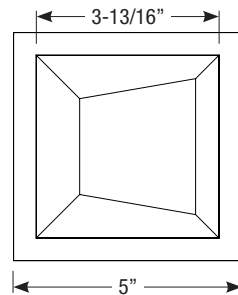
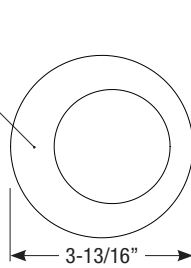
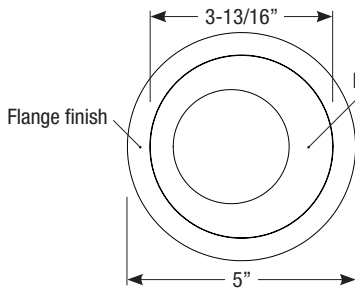
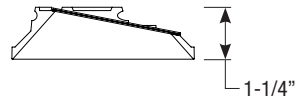
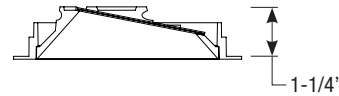
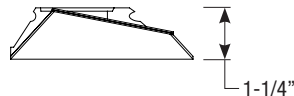
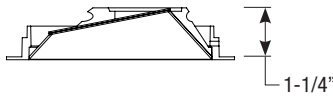

Spec-00157 Revised 06/04/2020