

3" acrobat LED Pinhole Downlight

Non-IC Shallow New Construction Housing

Round or Square / Trimmed or Trimless

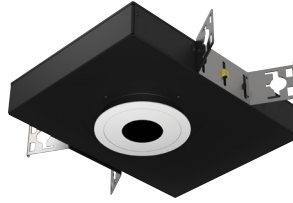

Wattage	CCT	Delivered Lumens	Efficacy
10W	3000K	858lm	86lpw
15W	3000K	1335lm	89lpw
20W	3000K	1604lm	80lpw
25W	3000K	1907lm	76lpw

Lumens will vary depending on CCT, optic & lens option

Description

- Acrobat pinhole downlight delivers over 1900lm through a 2" pinhole with four optical distributions. Delivered lumens are maintained in different ceiling thicknesses.
- Ceiling access needed.

Field Replaceable LED Light Engine

- 10W, 15W, 20W or 25W LED with 2 SDCM binning
- 2700K, 3000K, 3500K or 4000K at 90 CRI
- Field replaceable optics available in spot, narrow flood, flood or wide flood
- 50,000 hours at 70% lumen maintenance (L70)

Field Replaceable Dimming Driver

- Power factor > 0.9, 50/60Hz
- Multiple dimming drivers available
- Complies with IEEE62.41 surge protection

Housing

Non-IC rated housing must be kept a minimum of 3" from insulation. 18 gauge galvanized steel housing and junction box with 1/2" trade size knockouts. Includes universal butterfly brackets to accommodate C-Channel, adjustable bar hangers, and EMT. C-Channel is recommended for T-bar ceilings and must be ordered separately. Adjustable wood joist bar hangers are included. Max. ambient temperature: 104°F (40°C)

Ceiling Thickness

- Accommodates ceiling thickness from 1/2" to 1-1/4" (Extended 2" collar available, must specify)
- Delivered lumens are maintained through entire range

Trim Style

- Die-cast aluminum pinhole trim with powder coat finishes, consult factory for custom finishes
- Trimless mud plate and wood ceiling option available

Accessories

Accommodates (2) accessories, a media holder is required. Accessories are not compatible when used with lensed trim.

Emergency

Remote inverter operates for 90 minutes with remote test switch available, requires above ceiling access.

Listing/Warranty

- Patent pending
- Five (5) year limited warranty
- UL listed to US and Canadian standards for damp locations
- UL listed to US and Canadian standards for wet locations when used with lens



Housing Order Matrix (Example: A3-NCSP15S2730-R00)

Installation Type	Wattage	Driver	CCT / CRI	Optic	Aperture	Trim Style	Rev	Extended Collar
A3-NCSP (Non-IC)	10 (10W)	S² (ERP, Universal Dim, Triac/ELV/0-10V 10% 120-277V)	27 (2700K / 90 CRI)	10 (Spot)	-R (Round) -S (Square)	(blank) (Flanged) TL (Trimless) WC (Wood Ceiling)	00	(blank) (Standard 1-1/4") -2 (Up to 2")
	15 (15W)	L1¹ (Lutron Hi-lume [®] 2-Wire 1% 120V) L2¹ (Lutron EcoSystem [®] 5% 120-277V) L3¹ (Lutron Hi-lume [®] Fade-to-Black 1% 120-277V) L4¹ (Lutron Hi-lume [®] 3-Wire 1% 120-277V) EL1¹ (eldoLED DALI 1% 120-277V) EL2¹ (eldoLED 0-10V 1% 120-277V) DMX¹ (DMX 1% 120-277V) LR1 (Remote Lutron Hi-lume [®] 2-Wire 1% 120V) SR1 (Remote ERP, Universal Dim, Triac/ELV/0-10V 10% 120-277V)	30 (3000K / 90 CRI)	30 (Narrow Flood)				
	20 (20W)		35 (3500K / 90 CRI)	50 (Flood)				
	25 (25W)		40 (4000K / 90 CRI)	80 (Wide Flood)				

- Ceiling access required
- Forward and reverse phase dimming at 120V only

Trim Order Matrix (Example: A3-3RWH-WH-NL-00)

Trim	Aperture	Pinhole Finish	Flange Finish	Lens Type	Rev
A3-3	R (Round) S (Square)	WH (White)	(blank) (Trimless / Wood Ceiling)	-NL (No Lens - damp location) -FR (Frosted - wet location) -MP (Solite - wet location) -CL (Clear - wet location)	-00
		BL (Black)	-WH (White)		
		SA (Satin Aluminum)	-BL (Black)		
		BZ (Bronze)	-SA (Satin Aluminum) -BZ (Bronze)		

Accessories (Note: Media holder required)

A3-MHLDR (Media Holder - required)
A3-HEX (Hex Louver)
A3-FR (Frosted Lens)
A3-MP (Solite Lens)
A3-CL (Clear Lens)
A3-LS (Linear Spread Lens)

C-Channel Bar Hangers

LCB-27 (27" C-Channel)
LCB-52 (52" C-Channel)

Optics

A3-10-OPTIC (10° Spot)
A3-30-OPTIC (30° Narrow Flood)
A3-50-OPTIC (50° Flood)
A3-80-OPTIC (80° Wide Flood)

Emergency

EM-1000 (25W LED Remote Inverter)
EM-1002 (10W LED Remote Emergency Driver)
EM-1003 (35W LED Remote Inverter)
EM-1004 (50W LED Remote Inverter)

3" acrobat LED Pinhole Downlight
Non-IC Shallow New Construction Housing
 Round or Square / Trimmed or Trimless

Catalog #:

Type:

Project:

Date:

Notes:

Housing Dimensions

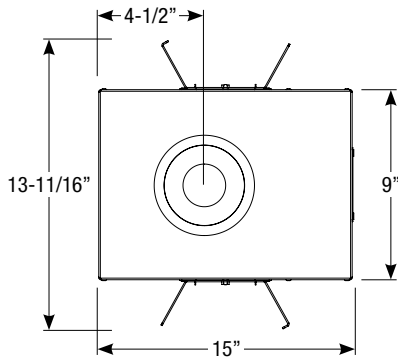
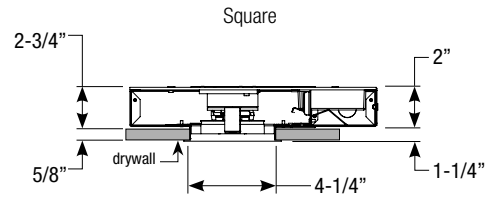
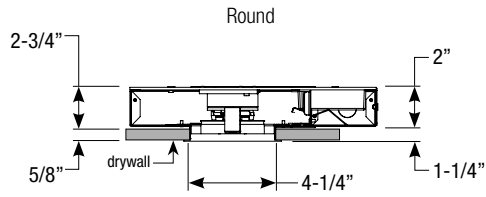

Ceiling Cut-out: 4-3/8" Ø

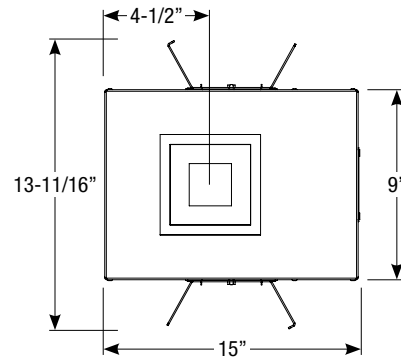

Ceiling Cut-out: 4-3/8" x 4-3/8"

Trim Dimensions

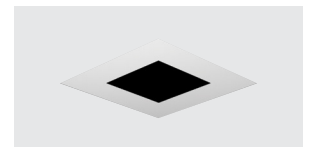
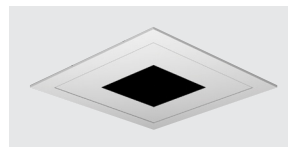
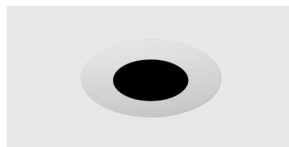
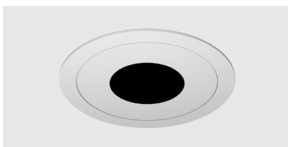
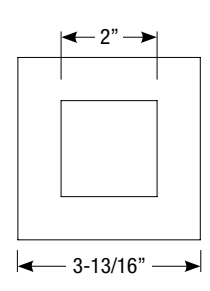
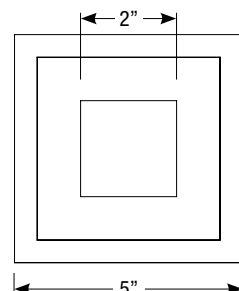
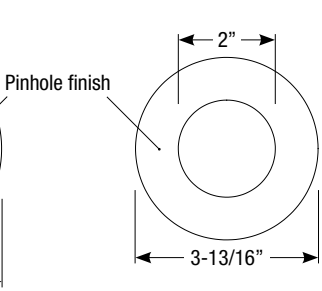
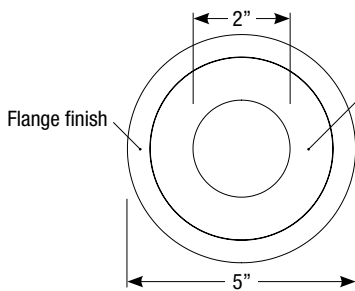
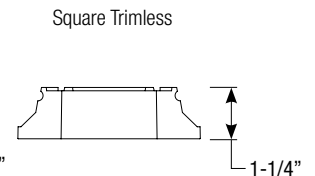
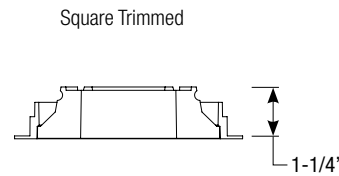
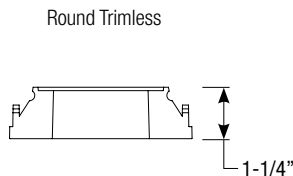
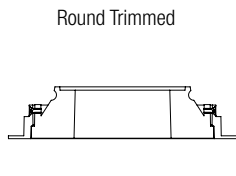

Revised 10/24/18