

2" acrobat LED Baffle Downlight

IC/CP Shallow New Construction Housing

Round or Square / Trimmed or Trimless

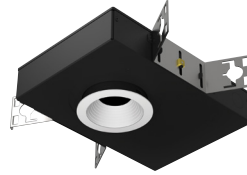

Wattage	CCT	Delivered Lumens	Efficacy
10W	3000K	795lm	79lpw
15W	3000K	1184lm	79lpw

Lumens will vary depending on CCT, optic & lens option

Description

Acrobat Air Tight IC/Chicago Plenum baffle downlight delivers over 1150lm through a 2" aperture with four optical distributions. Delivered lumens are maintained in different ceiling thicknesses.

Field Replaceable LED Light Engine

- 10W or 15W LED with 2 SDCM binning
- 2700K, 3000K, 3500K or 4000K at 90 CRI
- Field replaceable optics available in spot, narrow flood, flood or wide flood
- 50,000 hours at 70% lumen maintenance (L70)

Field Replaceable Dimming Driver

- Power factor > 0.9, 50/60Hz
- Multiple dimming drivers available
- Complies with IEEE62.41 surge protection

Housing

18 gauge galvanized steel housing and junction box with 1/2" trade size knockouts. Includes universal butterfly brackets to accommodate C-Channel, adjustable bar hangers, and EMT. C-Channel is recommended for T-bar ceilings and must be ordered separately. Adjustable wood joist bar hangers are included. Max. ambient temperature: 104°F (40°C)

Ceiling Thickness

- Accommodates ceiling thickness from 1/2" to 1-1/4" (Extended 2" collar available, must specify)
- Delivered lumens are maintained through entire range

Trim Style

- Die-cast aluminum baffle trim with powder coat finishes, consult factory for custom finishes
- Trimless mud plate and wood ceiling option available

Accessories

Accommodates (2) accessories, a media holder is required. Accessories are not compatible when used with lensed trim.

Emergency

Remote inverter operates for 90 minutes with remote test switch available, requires above ceiling access.

Listing/Warranty

- Patent pending
- Five (5) year limited warranty
- UL listed to US and Canadian standards for damp locations
- UL listed to US and Canadian standards for wet locations when used with lens
- Meets ASTM E283 standards
- CCEA approved - Chicago rated



Housing Order Matrix (Example: A2-SP15S2730-R00)

Installation Type	Wattage	Driver	CCT / CRI	Optic	Aperture	Trim Style	Rev	Extended Collar
A2-SP (IC/CP)	10 (10W) 15 (15W)	S' (ERP, Universal Dim, Triac/ELV/0-10V 10% 120-277V) LR1 (Remote Lutron Hi-lume® 2-Wire 1% 120V) SR1 (Remote ERP, Universal Dim, Triac/ELV/0-10V 10% 120-277V)	27 (2700K / 90 CRI)	10 (Spot)	-R (Round) -S (Square)	(blank) (Flanged) TL (Trimless) WC (Wood Ceiling)	00	(blank) (Standard 1-1/4") -2 (Up to 2")
			30 (3000K / 90 CRI)	30 (Narrow Flood)				
			35 (3500K / 90 CRI)	50 (Flood)				
			40 (4000K / 90 CRI)	80 (Wide Flood)				

1. Forward and reverse phase dimming at 120V only

Trim Order Matrix (Example: A2-2RWH-WH-NL-00)

Trim	Aperture	Reflector Finish	Flange Finish	Lens Type	Rev
A2-2	R (Round) S (Square)	WH (White)	(blank) (Trimless / Wood Ceiling)	-NL (No Lens - damp location)	-00
		CA² (Clear Alzak)	-WH (White)	-FR (Frosted - wet location)	
		BL (Black)	-BL (Black)	-MP (Solite - wet location)	
		SA (Satin Aluminum)	-SA (Satin Aluminum)	-CL (Clear - wet location)	
		BZ (Bronze)	-BZ (Bronze)		

2. Available in round aperture only

Accessories (Note: Media holder required)

- A2-MHLDR** (Media Holder- required)
- A2-HEX** (Hex Louver)
- A2-FR** (Frosted Lens)
- A2-MP** (Solite Lens)
- A2-CL** (Clear Lens)
- A2-LS** (Linear Spread Lens)

C-Channel Bar Hangers

- LCB-27** (27" C-Channel)
- LCB-52** (52" C-Channel)

Optics

- A2-10-OPTIC** (10° Spot)
- A2-30-OPTIC** (30° Narrow Flood)
- A2-50-OPTIC** (50° Flood)
- A2-80-OPTIC** (80° Wide Flood)

Emergency

- EM-1000** (25W LED Remote Inverter)
- EM-1002** (10W LED Remote Emergency Driver)
- EM-1003** (35W LED Remote Inverter)
- EM-1004** (50W LED Remote Inverter)

2" acrobat LED Baffle Downlight
IC/CP Shallow New Construction Housing
 Round or Square / Trimmed or Trimless

Catalog #:

Type:

Project:

Date:

Notes:

Housing Dimensions

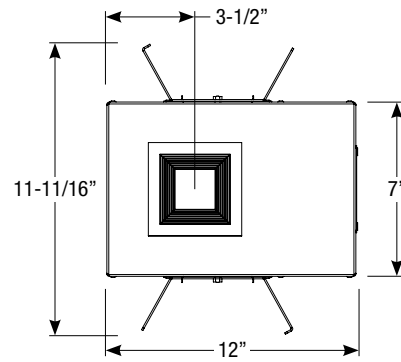
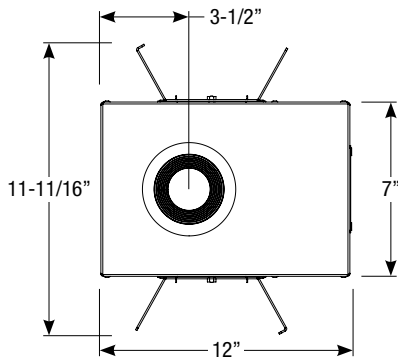
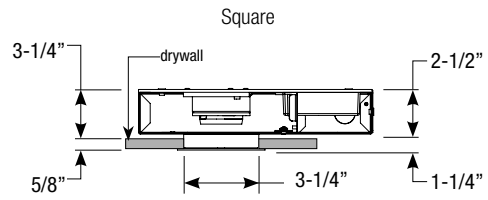
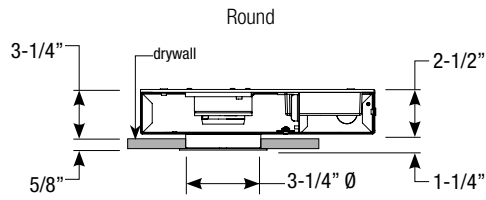

Ceiling Cut-out: 3-3/8" Ø

Ceiling Cut-out: 3-3/8" x 3-3/8"

Trim Dimensions

Round Trimmed

Round Trimless

Square Trimmed

Square Trimless

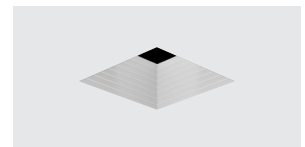
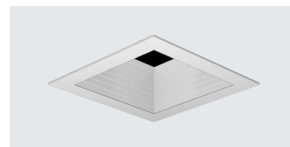
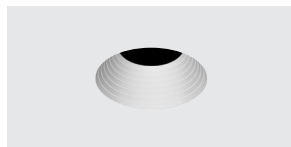
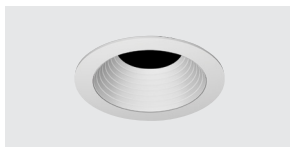
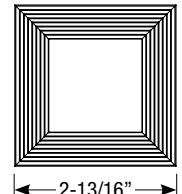
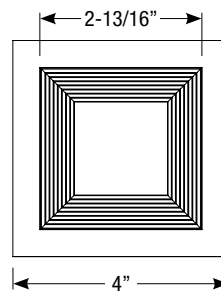
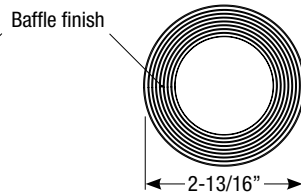
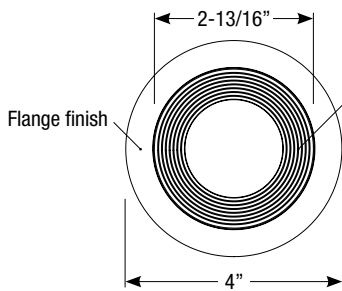
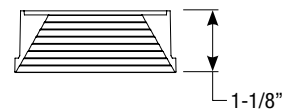
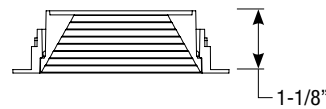
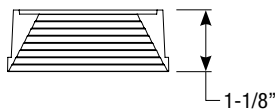
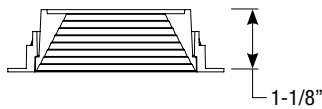

Revised 10/23/18