

1" acrobat LED Downlight

Non-IC Shallow New Construction Housing

Round or Square / Trimmed or Trimless

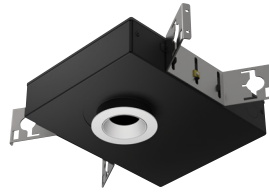

Wattage	CCT	Delivered Lumens	Efficacy
10W	3000K	781lm	78lpw
15W	3000K	1163lm	78lpw

Lumens will vary depending on CCT, optic & lens option

Description

Acrobat downlight delivers over 1150lm through a 1" aperture with four optical distributions. Delivered lumens are maintained in different ceiling thicknesses.

Field Replaceable LED Light Engine

- 10W or 15W LED with 2 SDCM binning
- 2700K, 3000K, 3500K or 4000K at 90 CRI
- Field replaceable optics available in spot, narrow flood, flood or wide flood
- 50,000 hours at 70% lumen maintenance (L70)

Field Replaceable Dimming Driver

- Power factor > 0.9, 50/60Hz
- 120-277V input
- Triac / 0-10V / ELV (120V only) dimming
- Complies with IEEEC62.41 surge protection

Housing

Non-IC rated housing must be kept a minimum of 3" from insulation. 18 gauge galvanized steel housing and junction box with 1/2" trade size knockouts.

Includes universal butterfly brackets to accommodate C-Channel, adjustable bar hangers, and EMT. C-Channel is recommended for T-bar ceilings and must be ordered separately. Adjustable wood joist bar hangers are included. Max. ambient temperature: 104°F (40°C)

Ceiling Thickness

- Accommodates ceiling thickness from 1/2" to 1-1/4" (Extended 2" collar available, must specify)
- Delivered lumens are maintained through entire range

Trim Style

- Round spun aluminum trim with anodized finishes, consult factory for custom finishes
- Square die-cast aluminum trim with powder coat finishes, consult factory for custom finishes
- Trimless mud plate and wood ceiling option available

Accessories

Accommodates (2) accessories, a media holder is required. Accessories are not compatible when used with lensed trim.

Emergency

Remote inverter operates for 90 minutes with remote test switch available, requires above ceiling access.

Listing/Warranty

- Patent pending
- Five (5) year limited warranty
- UL listed to US and Canadian standards for damp locations
- UL listed to US and Canadian standards for wet locations when used with lens



Housing Order Matrix (Example: A1-NCSP152730S-R00)

Installation Type	Wattage	Driver	CCT / CRI	Optic	Aperture	Trim Style	Rev	Extended Collar
A1-NCSP (Non-IC)	10 (10W)	S' (ERP, Universal Dim, Triac/ELV/0-10V 10% 120-277V) LR1 (Remote Lutron Hi-Lume® 2-Wire 1% 120V) SR1 (Remote ERP, Universal Dim, Triac/ELV/0-10V 10% 120-277V)	27 (2700K / 90 CRI)	10 (Spot)	-R (Round) -S (Square)	(blank) (Flanged) TL (Trimless) WC (Wood Ceiling)	00	(blank) (Standard 1-1/4") -2 (Up to 2")
	15 (15W)		30 (3000K / 90 CRI)	30 (Narrow Flood)				
			35 (3500K / 90 CRI)	50 (Flood)				
			40 (4000K / 90 CRI)	80 (Wide Flood)				

1. Forward and reverse phase dimming at 120V only

Trim Order Matrix (Example: A1-1RWH-WH-NL-00)

Trim	Aperture	Reflector Finish	Flange Finish	Lens Type	Rev
A1-1	R (Round) S (Square)	WH (White)	(blank) (Trimless)	-NL (No Lens - damp location) -FR (Frosted - wet location) -MP (Solite - wet location) -CL (Clear - wet location)	-00
		CA² (Clear Alzak)	-WH (White)		
		BL (Black)	-BL (Black)		
		SA (Satin Aluminum)	-SA (Satin Aluminum)		
		BZ (Bronze)	-BZ (Bronze)		

2. Available in round aperture only

Accessories (Note: Media holder required)

A1-MHLDR (Media Holder- required)
A1-HEX (Hex Louver)
A1-FR (Frosted Lens)
A1-MP (Solite Lens)
A1-CL (Clear Lens)
A1-LS (Linear Spread Lens)

C-Channel Bar Hangers

LCB-27 (27" C-Channel)
LCB-52 (52" C-Channel)

Optics

A1-10-OPTIC (10° Spot)
A1-30-OPTIC (30° Narrow Flood)
A1-50-OPTIC (50° Flood)
A1-80-OPTIC (80° Wide Flood)

Emergency

EM-1000 (25W LED Remote Inverter)
EM-1002 (10W LED Remote Emergency Driver)
EM-1003 (35W LED Remote Inverter)
EM-1004 (50W LED Remote Inverter)

1" acrobat LED Downlight

Non-IC Shallow New Construction Housing

Round or Square / Trimmed or Trimless

Catalog #:

Type:

Project:

Date:

Notes:

Housing Dimensions

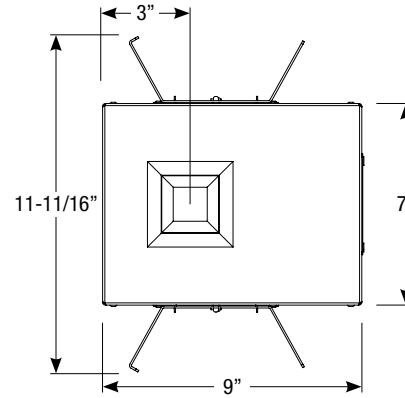
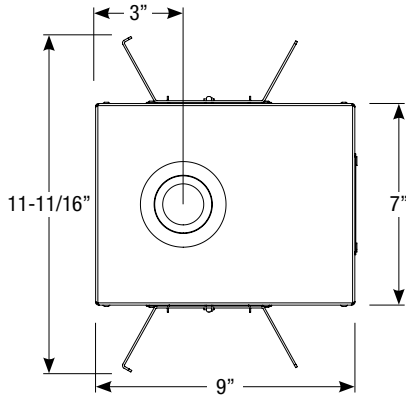
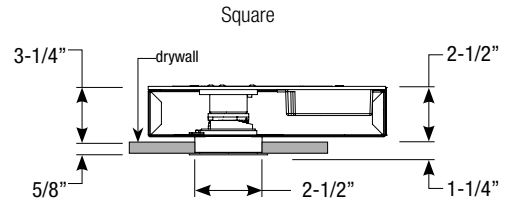
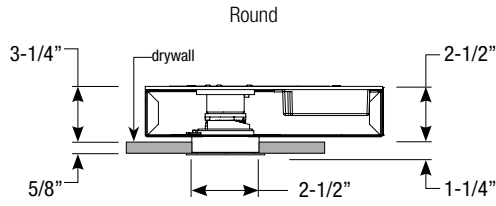

Ceiling Cut-out: 2-5/8" Ø

Ceiling Cut-out: 2-5/8" x 2-5/8"

Trim Dimensions

Round Trimmed

Round Trimless

Square Trimmed

Square Trimless

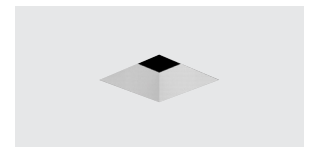
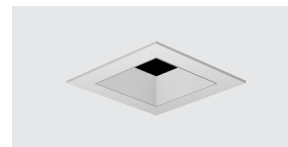
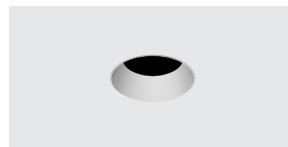
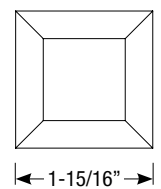
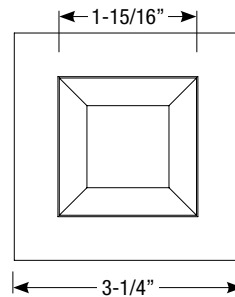
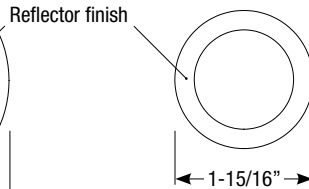
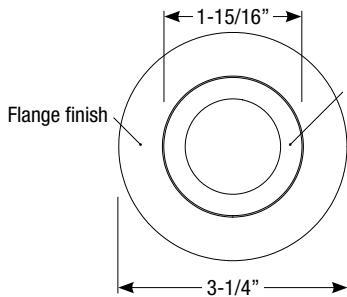
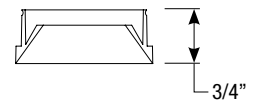
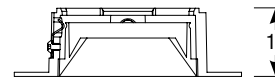
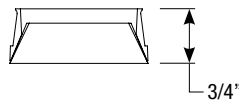
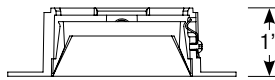

Revised 12/14/18