

1" Eco-Downlight

Non-IC Remodel Housing

Round or Square

Wattage	CCT	Delivered Lumens	Efficacy
8.5W	2700K	750lm	88lpw
8.5W	3000K	800lm	94lpw
13W	2700K	950lm	73lpw
13W	3000K	1050lm	81lpw
13W	3500K	1150lm	88lpw

Lumens will vary depending on optic, finish & trim type

Dimensions

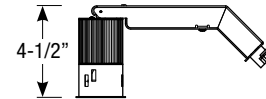
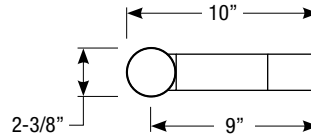

Ceiling Cut-out: 2-1/4" Ø

LED Light Engine

- 8.5W LED with 2700K or 3000K @ 90 CRI
- 13W LED with 2700K, 3000K or 3500K @ 90 CRI
- 2 SDCM binning
- 50,000 hours at 70% lumen maintenance (L70)

Field Replaceable Dimming Driver

- 8.5W Low power density (LPD) housings include an universal ELV / Triac driver with 120-277V input
- 13W housings are available with remote Lutron Hi-Lume® or universal 0-10V / ELV / Triac driver

Optics

50° flood optic included (10°, 30° and 80° optic are available, must specify)

Gasket for IC Air-Tight Installations

8.5W Low power density (LPD) housings can be converted to an IC Air-Tight housing with gasket, must specify EDLM-AT-GSKT.

Housing

- Non-IC rated, must be kept 3" from insulation
- Cold rolled steel junction box with black anodized finish, (2) 1/2" trade size knockouts
- Black oxide-coated, heat treated spring steel mounting clips (included)

Mounting

- Adjust vertically to accommodates ceiling thickness from 1/2" to 3/4"
- Requires a minimum ceiling depth of 6-1/2"

Trim

- Available in round or square aluminum trim, consult factory for custom finishes
- Available in open reflector, baffle or shower trim
- Flush mount adapter available

Emergency

Remote inverter operates for 90 minutes with remote test switch available, requires above ceiling access.

Listing/Warranty

- Five (5) year limited warranty
- UL listed to US and Canadian standards for damp locations (wet location when used with shower trim)
- CEC (Title 24) Listed when used with reflector or baffle



Housing Order Matrix (Example: EDLM-RM-27-4)

Installation Type	CCT / CRI	Rev	Wattage / Driver
EDLM-RM (Non-IC)	-27 (2700K / 90 CRI)	-4	(blank) ³ (13W / ERP, Universal Dim, Triac/ELV/0-10V 1% 120-277V)
	-30 (3000K / 90 CRI)		-LPD ² (8.5W / ERP, Universal Dim, Triac/ELV 1% 120-277V)
	-35 ¹ (3500K / 90 CRI)		

1. Not available with 8.5W LPD driver

2. Available in 2700K and 3000K only
3. Forward and reverse phase dimming at 120V only

Optics

EDLM-10-OPTIC-3 (10° Spot)
EDLM-30-OPTIC-3 (30° Narrow Flood)
EDLM-50-OPTIC-3 (50° Flood)
EDLM-80-OPTIC-3 (80° Wide Flood)

Emergency

EM-1000 (25W LED Remote Inverter)
EM-1002 (10W LED Remote Emergency Driver)
EM-1003 (35W LED Remote Inverter)
EM-1004 (50W LED Remote Inverter)

Gasket for IC Air-Tight ceilings

EDLM-AT-GSKT (Air-Tight IC Gasket for LPD housing only)

1" Eco-Downlight Open Reflector

Non-IC Remodel Housing

Round or Square

Catalog #:

Type:

Project:

Date:

Notes:

Open Reflector Trim Order Matrix (Example: EDLM-1002-3)

Series	Aperture / Finish	Rev
EDLM	-1001 (Round / Black Alzak Reflector / White Flange)	-3
	-1003 (Round / Black Alzak Reflector / Satin Aluminum Flange)	
	-1004 (Round / Haze Reflector / White Flange)	
	-1005 (Round / Haze Reflector / Satin Aluminum Flange)	
	-1006 (Round / White Reflector / White Flange)	
	-2001 (Square / Black Reflector / White Flange)	
	-2003 (Square / Black Reflector / Satin Aluminum Flange)	
	-2004 (Square / Haze Reflector / White Flange)	
	-2005 (Square / Haze Reflector / Satin Aluminum Flange)	
	-2006 (Square / White Reflector / White Flange)	

Flush Mount Adapter

EDLM-RD-FMA (Round Flush Mount Adapter)

EDLM-SQ-FMA (Square Flush Mount Adapter)

Dimensions

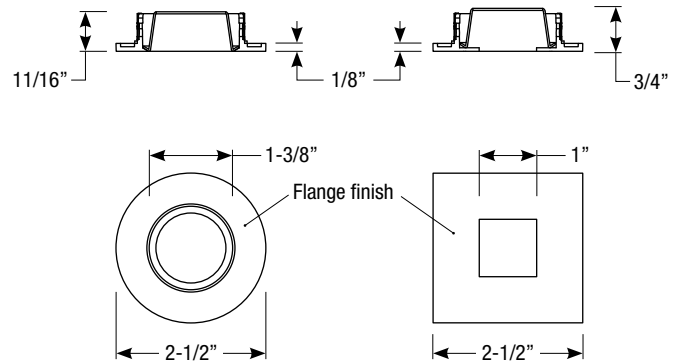

Note: Open reflector does not allow adjustable mechanism to tilt

Trim Finishes

EDLM-1001-3
Black Alzak Reflector
White Flange

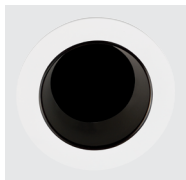

EDLM-1003-3
Black Alzak Reflector
Satin Aluminum Flange

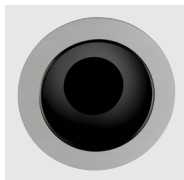

EDLM-1004-3
Haze Reflector
White Flange

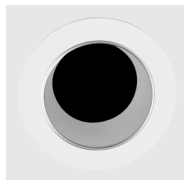

EDLM-1005-3
Haze Reflector
Satin Aluminum Flange

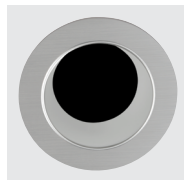

EDLM-1006-3
White Reflector
White Flange

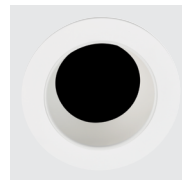

EDLM-2001-3
Black Reflector
White Flange

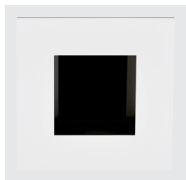

EDLM-2003-3
Black Reflector
Satin Aluminum Flange

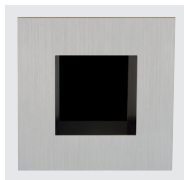

EDLM-2004-3
Haze Reflector
White Flange

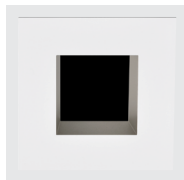

EDLM-2005-3
Haze Reflector
Satin Aluminum Flange

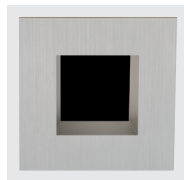

EDLM-2006-3
White Reflector
White Flange

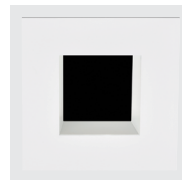

Revised 10/24/2022

1" Eco-Downlight Baffle Downlight

Non-IC Remodel Housing

Round or Square

Catalog #:

Type:

Project:

Date:

Notes:

Baffle Downlight Trim Order Matrix (Example: EDLM-1102-3)

Series	Aperture / Finish	Rev
EDLM	-1100 (Round / White Baffle / White Flange)	-3
	-1101 (Round / Black Baffle / White Flange)	
	-1102 (Round / Black Baffle / Satin Aluminum Flange)	
	-2100 (Square / White Baffle / White Flange)	
	-2101 (Square / Black Baffle / White Flange)	
	-2102 (Square / Black Baffle / Satin Aluminum Flange)	

Flush Mount Adapter

EDLM-RD-FMA (Round Flush Mount Adapter)
EDLM-SQ-FMA (Square Flush Mount Adapter)

Dimensions

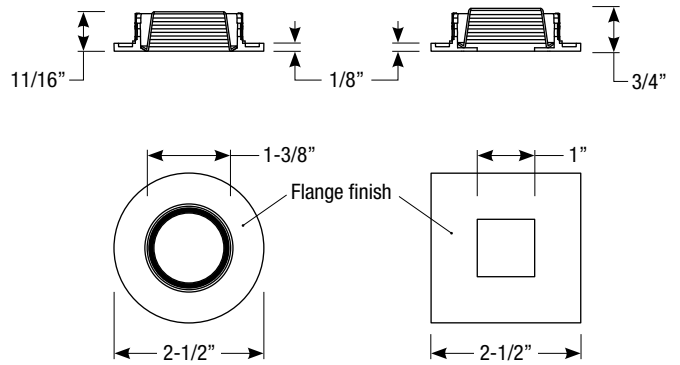

Note: Baffle downlight does not allow adjustable mechanism to tilt

Trim Finishes

EDLM-1100-3
White Baffle
White Flange



EDLM-1101-3
Black Baffle
White Flange



EDLM-1102-3
Black Baffle
Satin Aluminum Flange



EDLM-2100-3
White Baffle
White Flange

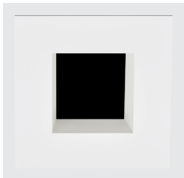

EDLM-2101-3
Black Baffle
White Flange

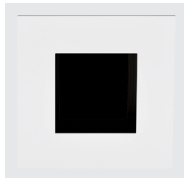

EDLM-2102-3
Black Baffle
Satin Aluminum Flange



1" Eco-Downlight Shower Trim

Non-IC Remodel Housing

Round or Square

Catalog #:

Type:

Project:

Date:

Notes:

Shower Trim Order Matrix (Example: EDLM-1200-3)

Series	Aperture / Finish	Rev
EDLM	-1200 (Round Shower Trim / White Flange)	-3
	-2200 (Square Shower Trim / White Flange)	

Flush Mount Adapter

EDLM-RD-FMA (Round Flush Mount Adapter)
EDLM-SQ-FMA (Square Flush Mount Adapter)

Trim Finishes

EDLM-1200-3
White Flange

EDLM-2200-3
White Flange



Dimensions

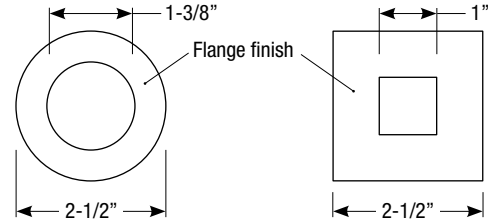
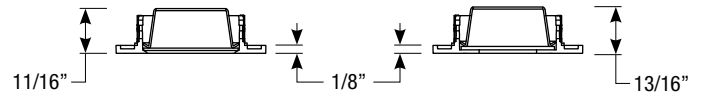

Note: Shower trim does not allow adjustable mechanism to tilt

Revised 10/24/2022