

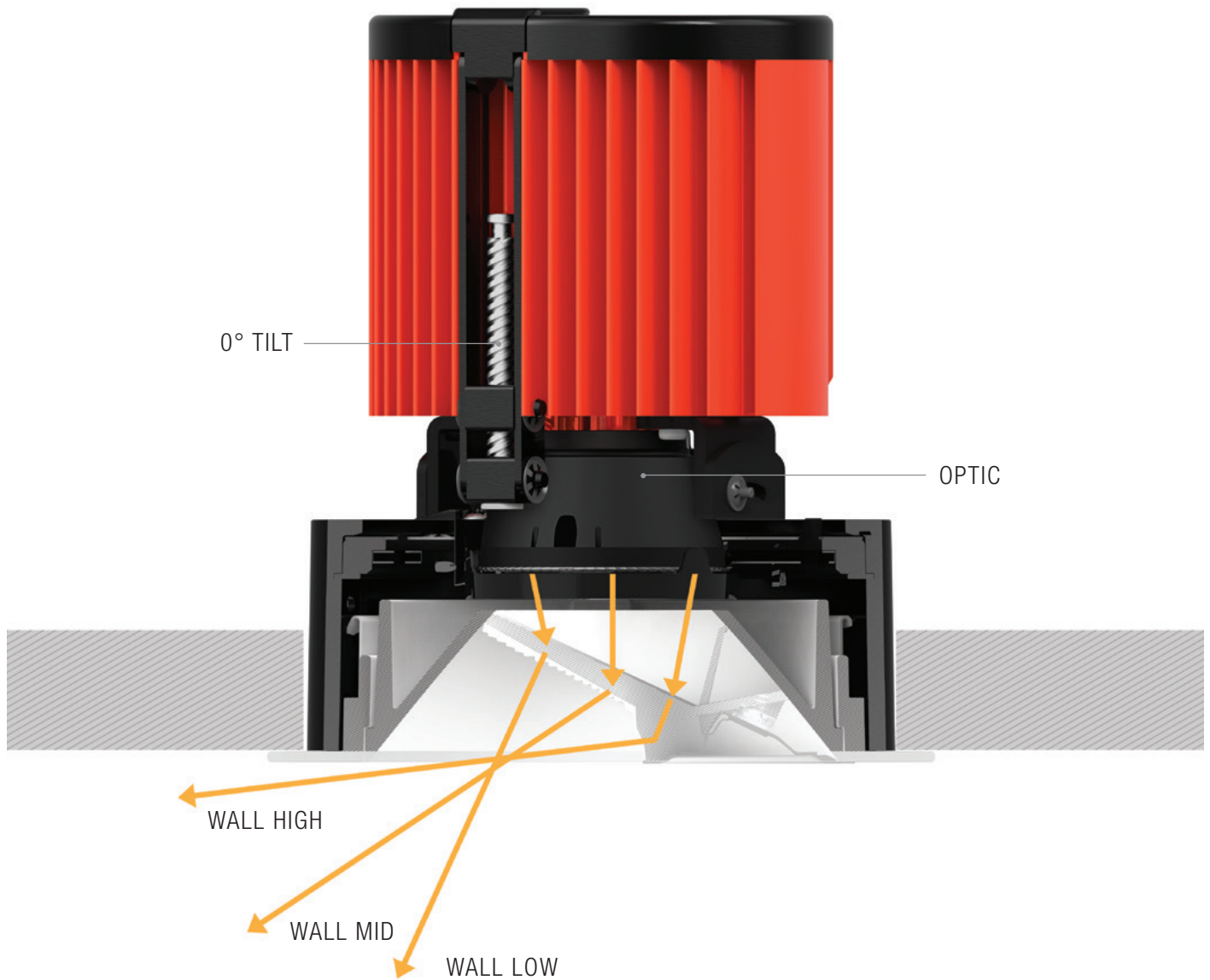

ULTIMATE PERFORMANCE IN WALL WASH
USER GUIDE

NEXT LEVEL PRECISION

Acrobat Wall Wash Optic is an innovative new product that converts standard Acrobat downlight trims to wall wash lighting. This newly patented technology goes beyond traditional track or downlights, delivering next-level precision when spotlighting wall art, sculpture, or signage.



The optic is positioned straight down (no tilt) and parallel to the wall, trim louvers redirect light rays toward the wall.

SIMPLE INSTALLATION

The Wall Wash Optic is simply snapped into place and rotated to create directional light.



A metal cover snaps in behind it to maintain a superior below ceiling aesthetic.

CONSIDERATIONS FOR ARTWORK

Example of a 36" tall painting mounted at 60" on center.



Light fixtures too far from the wall cause glare when viewed at eye level.



Here light fixtures are too close to the wall. This causes harsh shadows as well as over exposing the top and under exposing the bottom of art.



Light fixtures positioned at the correct distance of 3ft don't cause glare when viewed at eye level. At this distance, a painting can be evenly lit from top to bottom without harsh shadows.

CONSIDERATIONS FOR SPACING

24" Wall Wash Spacing

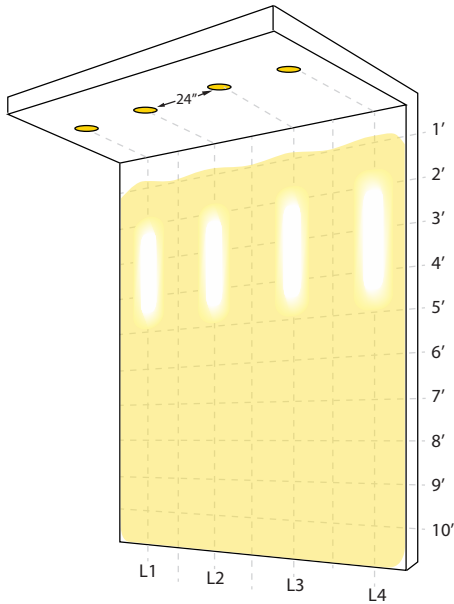

Tighter fixture spacings minimize scalloping between fixtures and create the most even wall wash possible. This comes at the increased cost of more fixtures on a project. CSL recommends 24" fixture spacing if your budget allows.

36" Wall Wash Spacing

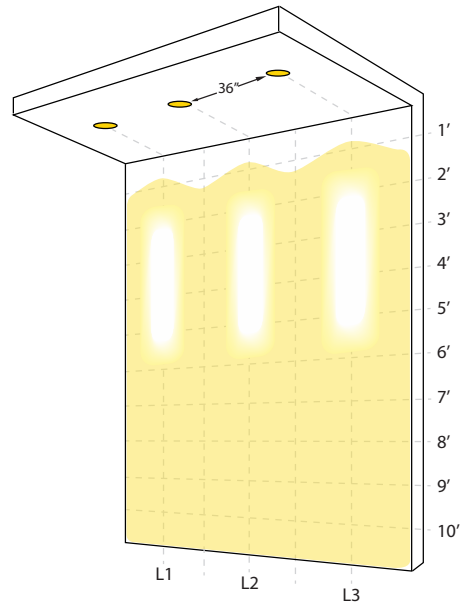

A 36" fixture spacing is a good compromise on minimizing scalloping and hot spots while still meeting the demands of a design budget. CSL recommends 36" fixture spacing for projects on a standard budget.

48" Wall Wash Spacing

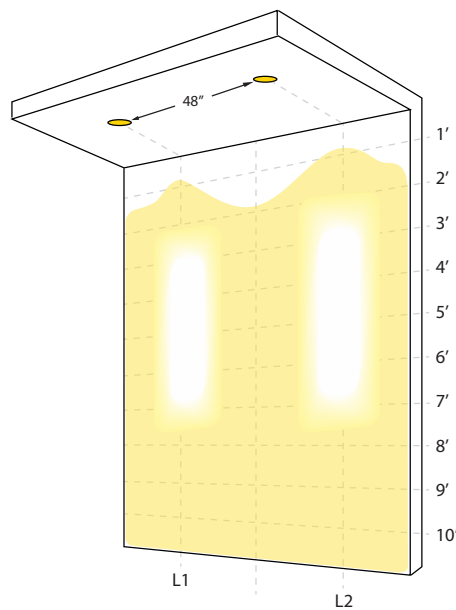

With 48" fixture spacing, hot spots and scalloping will be more obvious. CSL recommends a 48" fixture spacing on projects on a tight budget.

PROPERLY USE WALL WASH FOR ARTWORK

Example of a 36" tall painting mounted at 60" on center.

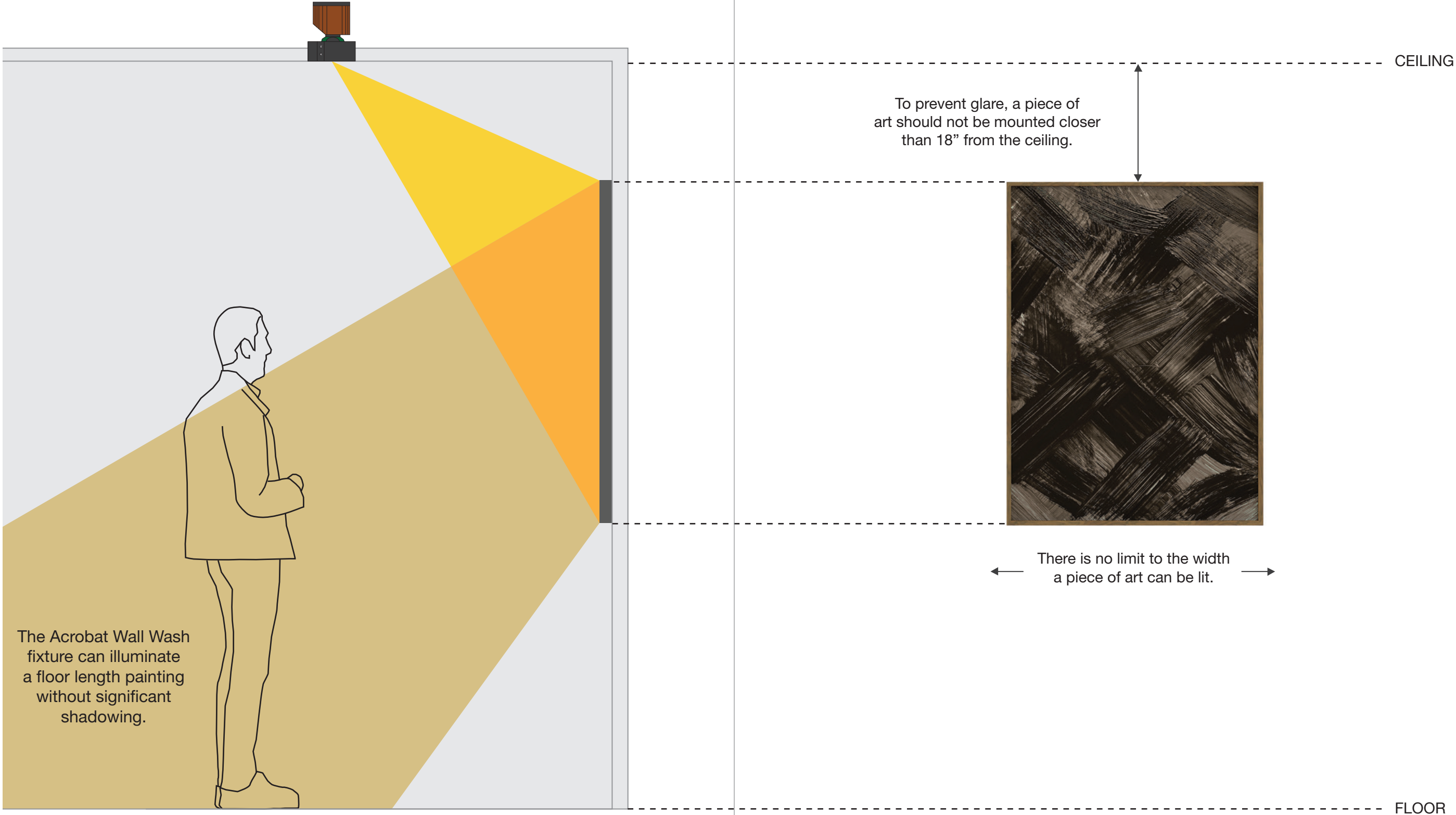

PLACEMENT

Wall Wash optic is to be oriented parallel with the wall. Place first fixture in the row 18" from a perpendicular wall. Subsequent fixtures should be placed 24", 36" or 48" apart.

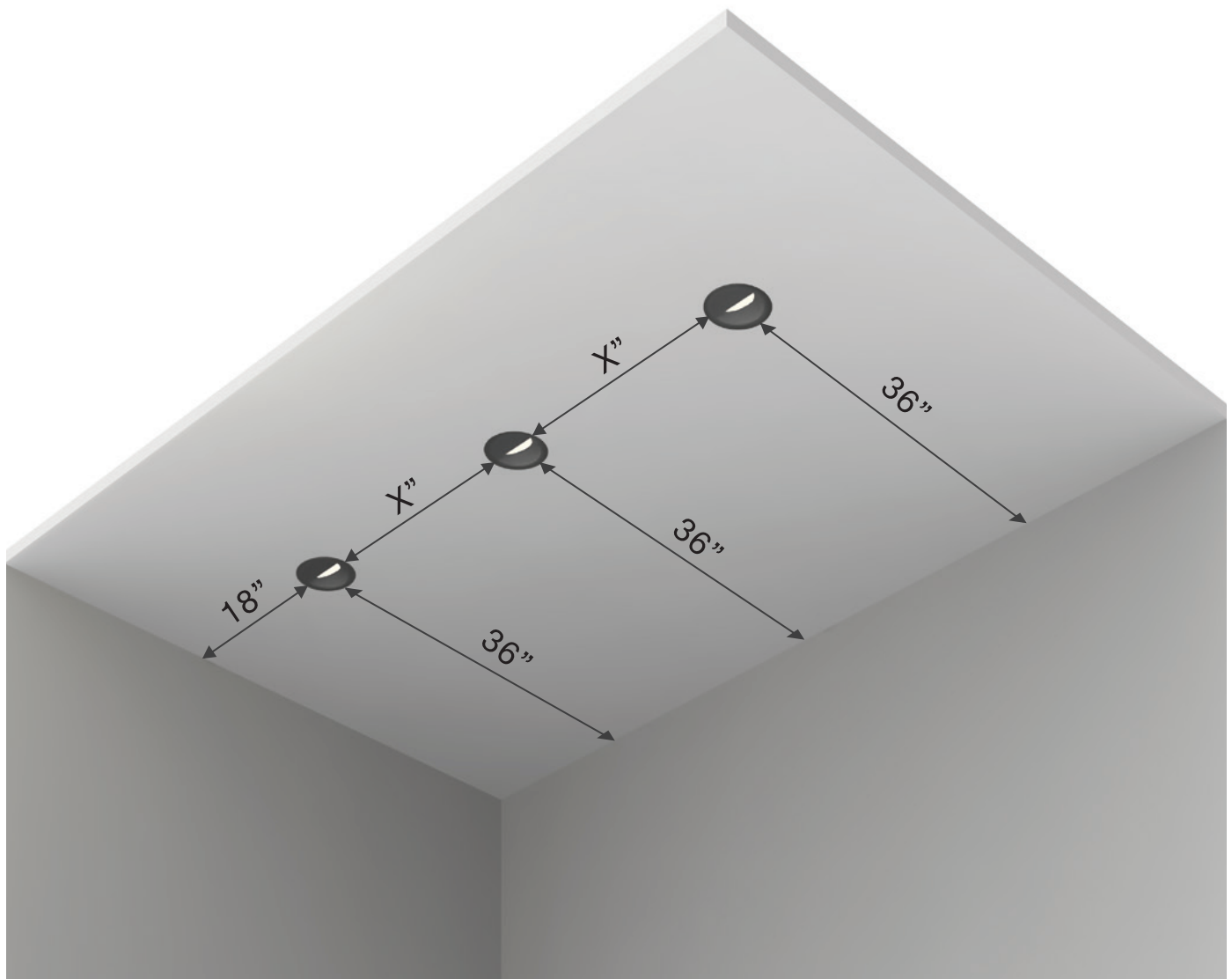

All fixtures should be placed 36" from the wall.

RESULT

The Wall Wash optic assembly will redirect light facing down and have it redistributed towards the wall.

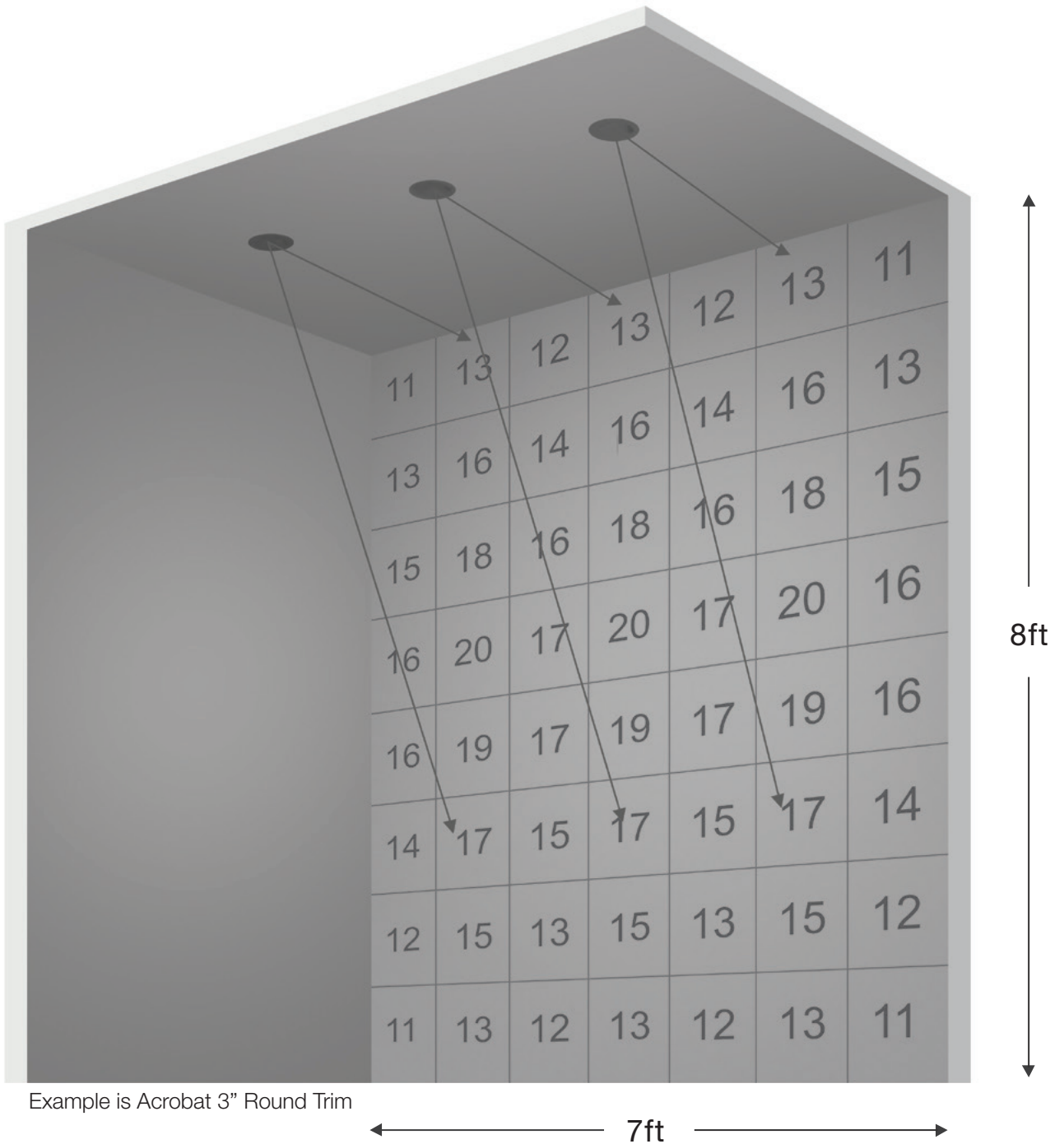

ACROBAT 1" WALL WASH 15W

24", 36", 48" SPACING

Distance from Ceiling (ft)	24" Apart			36" Apart			48" Apart		
1	6	6	6	7	6	7	5	5	5
2	6	6	6	7	7	7	5	5	5
3	7	6	7	7	6	7	5	5	5
4	8	7	8	7	7	7	5	5	5
5	8	7	8	7	6	7	5	5	5
6	7	7	7	6	6	6	5	4	5
7	7	6	7	6	5	6	5	4	5
8	6	6	6	5	5	5	4	3	4
9	5	5	5	5	5	5	4	3	4
10	5	5	5	4	4	4	3	3	3

Light intensity in foot candles

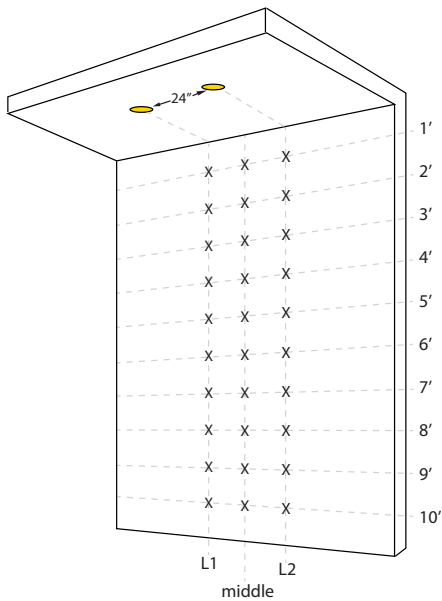

24" Wall Wash Spacing

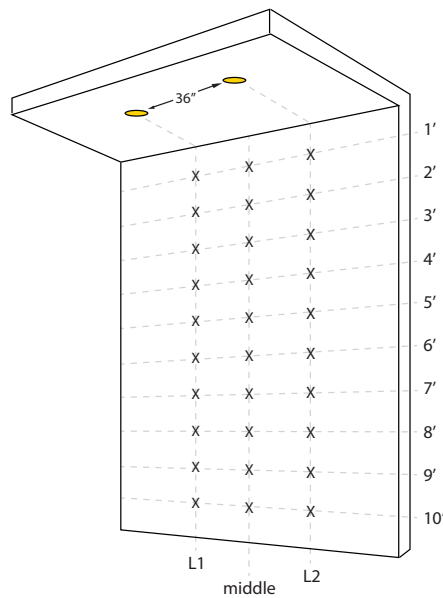

36" Wall Wash Spacing

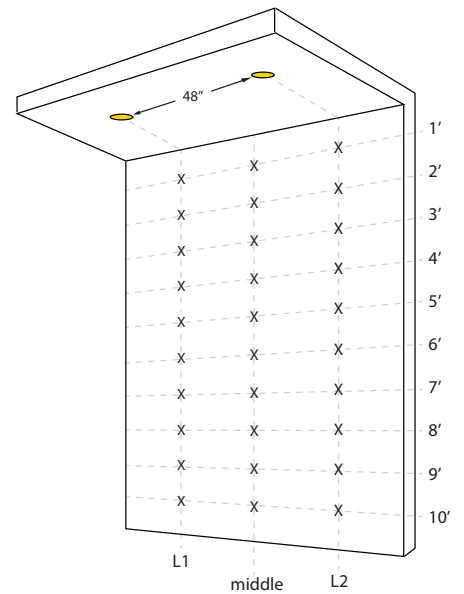

48" Wall Wash Spacing

ACROBAT 2" WALL WASH 20W

24", 36", 48" SPACING

Distance from Ceiling (ft)	24" Apart			36" Apart			48" Apart		
1	13	11	13	10	9	10	9	6	9
2	14	12	14	11	10	11	10	8	10
3	13	11	13	10	9	10	9	8	9
4	13	12	13	11	10	11	9	9	9
5	14	12	14	12	10	12	10	9	10
6	14	12	14	12	10	12	10	10	10
7	13	12	13	11	10	11	10	9	10
8	12	11	12	11	9	11	9	9	9
9	11	11	11	10	9	10	9	8	9
10	10	10	10	10	8	10	8	8	8

Light intensity in foot candles

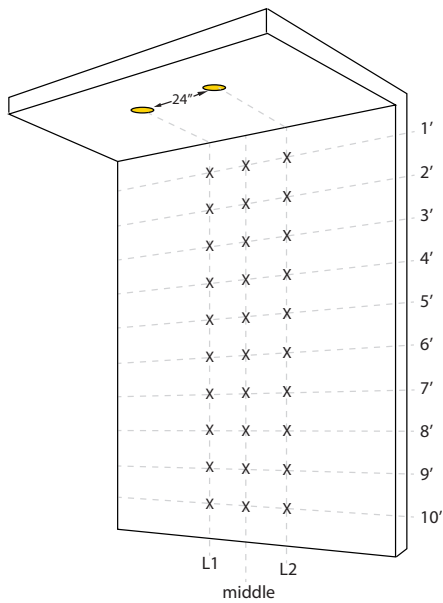

24" Wall Wash Spacing

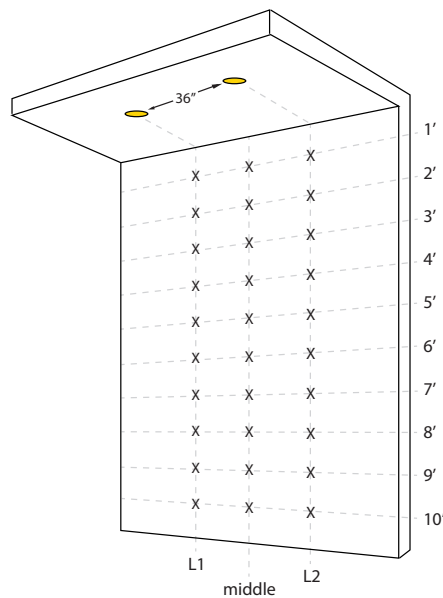

36" Wall Wash Spacing

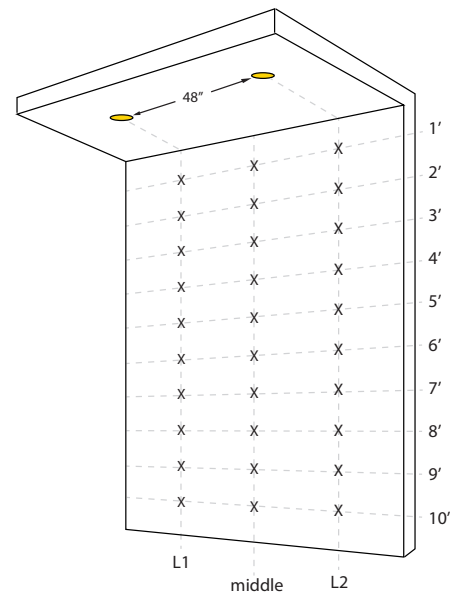

48" Wall Wash Spacing

ACROBAT 3" WALL WASH 25W

24", 36", 48" SPACING

Distance from Ceiling (ft)	24" Apart			36" Apart			48" Apart		
1	15	11	15	10	9	10	9	7	9
2	18	14	18	12	12	12	11	10	11
3	20	15	20	15	14	15	13	12	13
4	21	16	21	16	15	16	14	13	14
5	20	15	20	15	15	15	13	13	13
6	17	14	17	14	14	14	12	12	12
7	15	12	15	13	12	13	11	11	11
8	13	11	13	11	11	11	10	9	10
9	11	10	11	10	10	10	9	9	9
10	10	9	10	9	9	9	8	7	8

Light intensity in foot candles

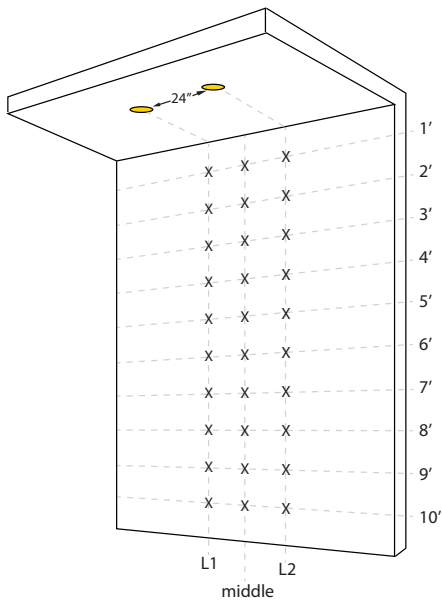

24" Wall Wash Spacing

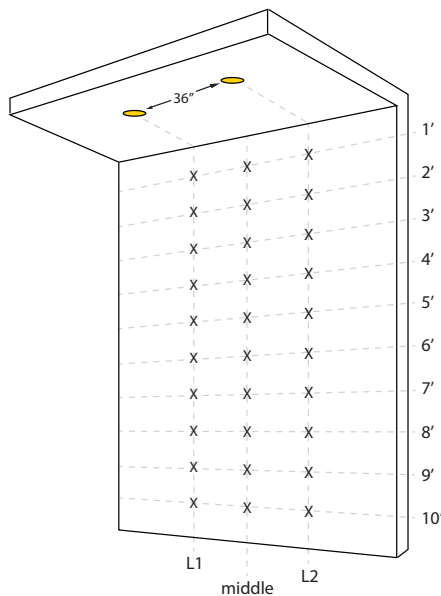

36" Wall Wash Spacing

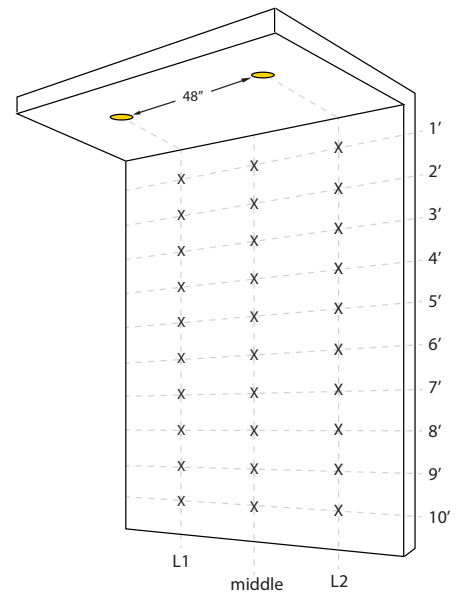

48" Wall Wash Spacing

ACROBAT 4" WALL WASH 35W

24", 36", 48" SPACING

Distance from Ceiling (ft)	24" Apart			36" Apart			48" Apart		
1	7	6	7	6	5	6	6	5	6
2	13	10	13	12	11	12	10	9	10
3	21	17	21	16	15	16	14	12	14
4	27	23	27	19	17	19	16	14	16
5	27	24	27	20	19	20	17	15	17
6	25	20	25	20	18	20	16	16	16
7	21	18	21	18	17	18	16	15	16
8	18	15	18	17	16	17	15	14	15
9	15	14	15	16	15	16	15	13	15
10	14	13	14	15	14	15	13	12	13

Light intensity in foot candles

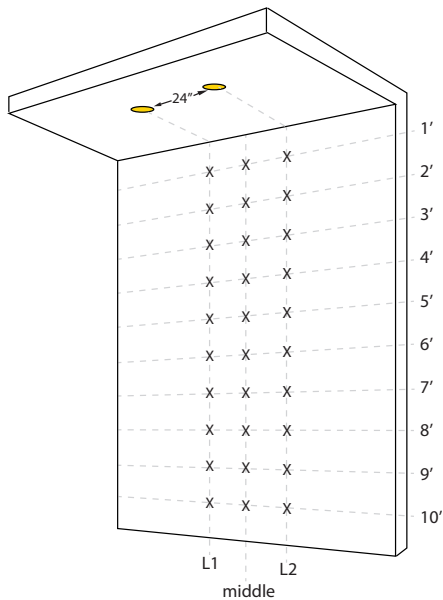

24" Wall Wash Spacing

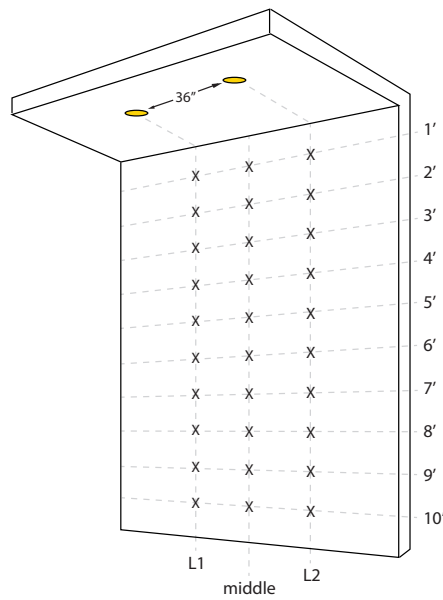

36" Wall Wash Spacing

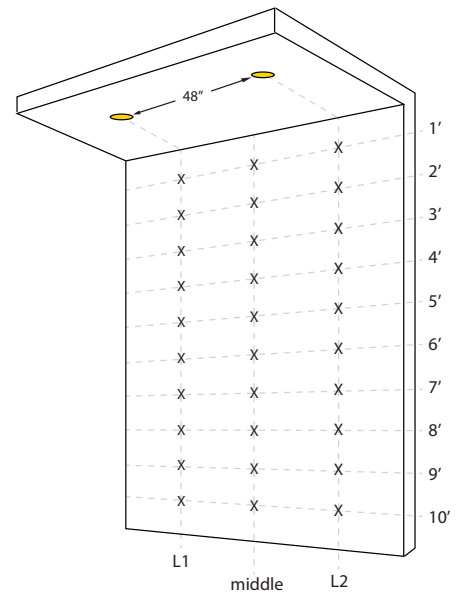

48" Wall Wash Spacing



*Acrobat*TM

DOWNLIGHTS



WET LOCATION

DAMP LOCATION

IC RATED

SSS AIRTIGHT



JA8 ^{TITLE 24} COMPLIANT
90 CRI OPTION ONLY

5 YEAR LIMITED WARRANTY

A Division of Troy-CSL Lighting, Inc.
14508 Nelson Avenue
City of Industry, CA 91744
P: 626.336.4511 • F: 626.330.4266
www.csllighting.com

Updated 01/2023

